

General Specifications

Digital I/O Modules (for FIO)



GS 33K50F70-50E

[Release 5]

■ GENERAL

This GS covers the hardware specifications of the Digital I/O Modules (FIO) that can be installed in the ESB Bus Node Unit (ANB10S, ANB10D), Optical ESB Bus Node Unit (ANB11S, ANB11D), the ER Bus Node Unit (ANR10S, ANR10D) and the Field Control Unit (AFV30S, AFV30D, AFV40S, AFV40D, AFF50S, AFF50D, AFV10S, AFV10D).

■ STANDARD SPECIFICATIONS

● Digital Input Modules

The Digital Input Modules receive 32-channel or 64-channel 24 V DC ON/OFF signals. The ADV151 and ADV161 can be used in dual redundant configuration.

Item	Specifications			
	Model	ADV151-P/ADV151-E (*1)	ADV157	ADV161
Number of input channels		32	32	64
Rated input voltage (*2)		24 V DC (sink/source)	24 V DC (sink/source)	24 V DC (sink/source)
Input ON voltage		18 to 26.4 V DC	18 to 26.4 V DC	20 to 26.4 V DC
Input OFF voltage		5.0 V DC or less	5.0 V DC or less	5.0 V DC or less
Input current (at rated input voltage)		4.1 mA±20 % / channel	4.1 mA±20 % / channel	2.5 mA±20 % / channel
Maximum allowable input voltage		30.0 V DC	30.0 V DC	30.0 V DC
Withstanding voltage	Between input signal and system: 2 kV AC, For 1 minute Between commons: 500 V AC, For 1 minute, common every 16-channel (*3)			
Functions				
Status input		Function for detecting ON/OFF status	Function for detecting ON/OFF status	Function for detecting ON/OFF status
Pushbutton input		Function for counting the pushbutton edges	—	Function for counting the pushbutton edges
Input response time	8 ms or less (for status input)			
Minimum ON detection time	20 ms (for pushbutton input)			
Maximum ON/OFF cycle	25 Hz (for pushbutton input)			
Maximum current consumption		500 mA (5 V DC)	350 mA (5 V DC)	550 mA (5 V DC)
Weight		0.3 kg	0.4 kg	0.3 kg
External connection		Pressure clamp terminal, Dedicated cable (AKB331), MIL connector cable	Pressure clamp terminal	Dedicated cable (AKB337), MIL connector cable

*1: ADV151-E cannot be installed in the ER Bus Node Unit.

*2: ADV151, ADV157 and ADV161 are common every 16-channel. All voltage input signals to be connected (24 V DC) must be in the same polarity.

*3: The withstanding voltage for using a dedicated cable is 500 V AC (between input signal and system). The withstanding voltage for using MIL connector cable depends on the electrical specifications of its cable.

● **AC Digital Input Modules**

The AC Digital Input Modules receive 16-channel 100 V AC or 220 V AC ON/OFF signals. They can be used in dual redundant configuration.

Item	Specifications	
	Model	ADV141
Number of input channels	16	16
Rated input voltage (*1)	100 to 120 V AC, 50/60 Hz	200 to 240 V AC, 50/60 Hz
Input ON voltage (peak value)	80 V AC (113 V) to 132 V AC (187 V)	160 V AC (226 V) to 264 V AC (373 V)
Input OFF voltage (peak value)	20 V AC (28 V) or less	40 V AC (56 V) or less
Input current (TYP)	4.7 mA (@120 V/60 Hz) / channel	6.2 mA (@240 V/60 Hz) / channel
Input current (MAX)	7 mA / channel	9.3 mA / channel
Withstanding voltage	Between input signal and system: 2 kV AC, For 1 minute Between commons: 1.35 kV AC, For 1 minute, common minus (-) side every 8-channel	
Functions		
Status input	Function for detecting ON/OFF status	
Pushbutton input	Function for counting the pushbutton edges	
Input response time	160 ms or less (for status input)	
Minimum ON detection time	200 ms (for pushbutton input)	
Maximum ON/OFF cycle	2.5 Hz (for pushbutton input)	
Maximum current consumption	500 mA (5 V DC)	500 mA (5 V DC)
Weight	0.3 kg	0.3 kg
External connection	Pressure clamp terminal, Dedicated cable (AKB332)	Pressure clamp terminal, Dedicated cable (AKB333)

Note: AC input signals to the same common should be the same phase.

*1: Input a sine wave, for AC signals.

● Digital Output Modules

The Digital Output Modules output 32-channel or 64-channel transistor contact signals.

The ADV551 and ADV561 can be used in dual redundant configuration.

Item Model	Specifications		
	ADV551	ADV557	ADV561
Number of output channels	32	32	64
Rated applied voltage	24 V DC	24 V DC	24 V DC
Load voltage	24 V DC, 50 mA	24 V DC, 50 mA	24 V DC, 100 mA
External power supply voltage range	20.4 to 26.4 V DC	20.4 to 26.4 V DC	20.4 to 26.4 V DC
Output ON voltage maximum value	2 V DC	2 V DC	2 V DC
Leak current maximum value when output OFF	0.1 mA	0.1 mA	0.1 mA
Output format	Current sink	Current sink	Current sink
Maximum load current (*1)	100 mA/channel, 26.4 V	100 mA/channel, 26.4 V	100 mA/channel, 26.4 V
Withstanding voltage	Between output signal and system: 2 kV AC, For 1 minute Between commons: 500 V AC, For 1 minute, common minus (–) side every 16-channel (*2)		
Functions			
Status output	ON/OFF status output function	ON/OFF status output function	ON/OFF status output function
Pulse width output	One-shot pulse width output function	—	One-shot pulse width output function
Time-proportioning output	Time-proportioning ON/OFF	—	Time-proportioning ON/OFF
Output response time	3 ms or less (for status output) 10 ms or less (for mixed status and pulse outputs)		
Pulse width	8 ms to 7200 s		
Pulse width resolution	8 ms, but ON/OFF delay of maximum 1 ms is added		
Maximum current consumption	700 mA (5 V DC) 60 mA (external power supply)	550 mA (5 V DC) 60 mA (external power supply)	700 mA (5 V DC) 120 mA (external power supply)
Weight	0.2 kg	0.3 kg	0.3 kg
External connection	Pressure clamp terminal, Dedicated cable (AKB331), MIL connector cable	Pressure clamp terminal	Dedicated cable (AKB337), MIL connector cable

*1: Connect a spark killer diode when driving DC relay.

*2: The withstanding voltage for using a dedicated cable is 500 V AC (between output signal and system).
The withstanding voltage for using MIL connector cable depends on the electrical specifications of its cable.

● Relay Output Module

The Relay Output Module outputs the 16-channel relay contact signals.
It can be used in dual redundant configuration.

Item	Specifications
Model	ADR541
Number of output channels	16
Rated applied voltage	24 to 110 V DC, 100 to 240 V AC, 50/60 Hz
Maximum load current (*1)	Resistive load: 24 V DC: 2.0 A/channel, 110 V DC: 0.4 A/channel 100 V AC: 2.0 A/channel, 220 V AC: 2.0 A/channel Inductive load: 24 V DC: 0.6 A/channel, 110 V DC: 0.1 A/channel 100 V AC: 1.0 A/channel, 220 V AC: 1.0 A/channel
Withstanding voltage	Between output signal and system: 2 kV AC, For 1 minute Between commons: 1.35 kV AC, For 1 minute, common minus (-) side every 8-channel
Functions	
Status output	ON/OFF status output function
Pulse width output	One-shot pulse width output function
Time-proportioning output	Time-proportioning ON/OFF
Output response time	12 ms or less (for status output) 20 ms or less (for mixed status and pulse outputs)
Pulse width	40 ms to 7200 s
Pulse width resolution	8 ms, but ON/OFF delay added for maximum 10 ms
Maximum current consumption	780 mA (5 V DC)
Weight	0.3 kg
External connection	Pressure clamp terminal, Dedicated cable (AKB334)
Relay switching life	100000 operations (*2)
Standards	Safety standard [CSA], EMC standards [C-Tick Marking], [KC Marking], Standard for Hazardous location equipment [CSA Non-Incendive]

Note: The signals connected the same common should be the same phase when applying AC voltage.

*1: Maximum 8 A is allowed per common. Connect a spark killer diode when driving DC relay.

*2: The relay cannot be replaced with new one. If it comes to the end of its life, the module should be replaced.

● Digital I/O Modules (CENTUM-ST Compatible)

The Digital I/O Modules (CENTUM-ST Compatible) receive contact or voltage status signals from the field, and/or output status signals to the field via transistor contacts.

Item	Specifications		
	Model	ADV859	ADV159
Number of I/O channels	16-channel input, 16-channel output	32-channel input	32-channel output
Signal isolation	Isolated channels	Isolated channels	Isolated channels
Input signal	Contact input: OFF signal 100 kΩ or more ON signal 200 Ω or less Minimum current value when contact is short-circuited: 1.25 mA Voltage input: OFF signal 4.5 to 25 V DC ON signal ±1 V DC, 200 Ω or less		–
Input contact rating	5 V DC, 20 mA or more		–
Pushbutton input function	Not supported	Supported	–
Input response time	8 ms (for status input)	8 ms (for status input)	–
Minimum ON detection time	–	20 ms (for pushbutton input)	–
Maximum ON/OFF cycle	–	25 Hz (for pushbutton input)	–
Output signal	Transistor contact	–	Transistor contact
Output contact rating	Inductive load, resistive load: 30 V DC, 100 mA (*1)	–	Inductive load, resistive load: 30 V DC, 100 mA (*1)
Output response time	16 ms or less	–	16 ms or less
Pulse width	8 ms to 7200 s	–	8 ms to 7200 s
Pulse width resolution	8 ms, add max. 1ms for ON/OFF delay time	–	8 ms, add max. 1ms for ON/OFF delay time
Maximum current consumption	450 mA (5 V DC)	330 mA (5 V DC)	570 mA (5 V DC)
Weight	0.3 kg	0.4 kg	0.3 kg
External connection	Dedicated cable (KS2)	Dedicated cable (KS2)	Dedicated cable (KS2)
Compatible card	ST2 compatible	ST3 compatible	ST4 compatible

*1: Connect a spark killer diode when driving DC relay.

Item	Specifications		
	Model	ADV869	ADV169
Number of I/O channels	32-channel input, 32-channel output	64-channel input	64-channel output
Signal isolation	Common every 16-channel	Common every 16-channel	Common every 16-channel
Input signal	Contact input: OFF signal 100 kΩ or more ON signal 200 Ω or less Minimum current value when contact is short-circuited: 1.25 mA Voltage input: OFF signal 4.5 to 25 V DC ON signal ±1 V DC, 200 Ω or less		–
Input contact rating	5 V DC, 20 mA or more		–
Pushbutton input function	Not supported	Not supported	–
Input response time	8 ms (for status input)	8 ms (for status input)	–
Output signal	Transistor contact	–	Transistor contact
Output contact rating	Inductive load, resistive load: 30 V DC, 100 mA (*1)	–	Inductive load, resistive load: 30 V DC, 100 mA (*1)
Output response time	16 ms or less	–	16 ms or less
Pulse width	8 ms to 7200 s	–	8 ms to 7200 s
Pulse width resolution	8 ms, add max. 1 ms for ON/ OFF delay time	–	8 ms, add max. 1 ms for ON/ OFF delay time
Maximum current consumption	800 mA (5 V DC)	800 mA (5 V DC)	800 mA (5 V DC)
Weight	0.3 kg	0.3 kg	0.3 kg
External connection	Dedicated cable (KS9)	Dedicated cable (KS9)	Dedicated cable (KS9)
Compatible card	ST5 compatible	ST6 compatible	ST7 compatible

*1: Connect a spark killer diode when driving DC relay.

● **Function Assignment in Digital Modules**

Select the patterns for assigning functions channel-by-channel in digital modules.

The following table lists the correspondence between the module types and point modes.

Table: Correspondence Between the Module Types and Point Modes

Point Mode	Module Type
SI	Status input
PB	Pushbutton input
SO	Status output
PW	Pulse width output
TP	Time-proportioning ON/OFF output

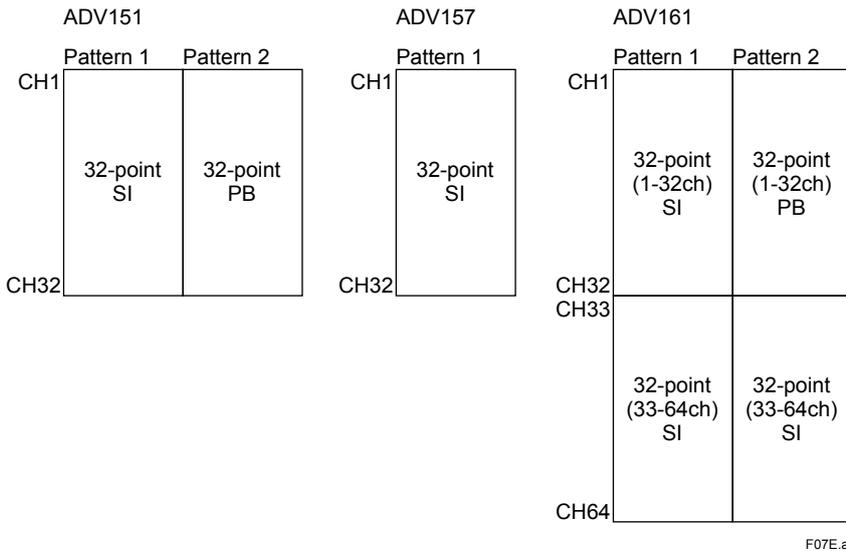

F07E.ai

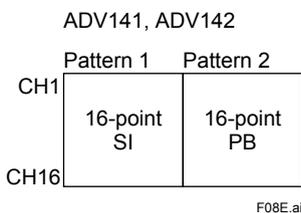

F08E.ai

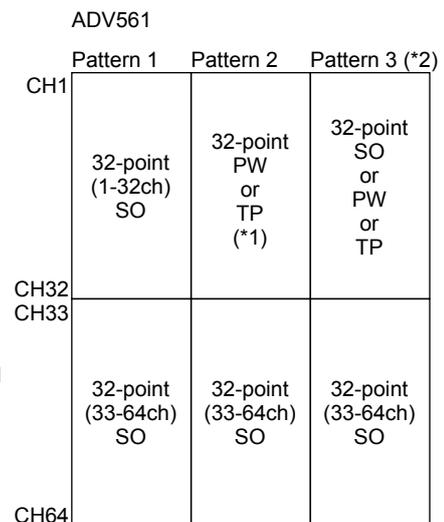
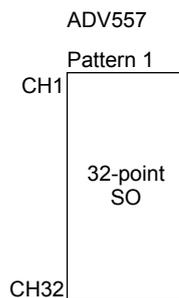
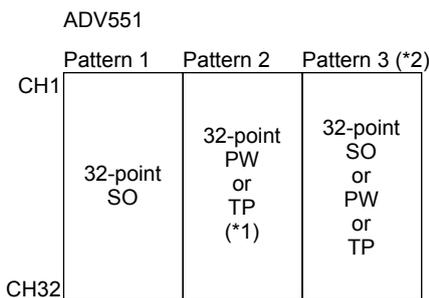

F09E.ai

- *1: If an odd-numbered terminal is specified as PW or TP, the next terminal cannot be specified as a different type.
- *2: This pattern applies only for direct-connected nodes. Dual redundancy is not possible.

ADR541

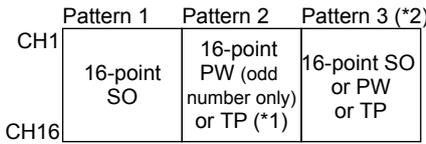

- *1: If an odd-numbered terminal is specified as PW or TP, the next terminal cannot be specified as a different type.
- *2: This pattern applies only for direct-connected nodes. Dual redundancy is not possible.

F10E.ai

ADV859 (ST2)

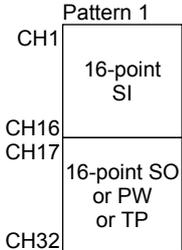

ADV159 (ST3)

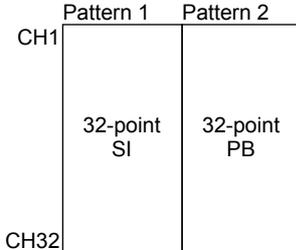

ADV559 (ST4)

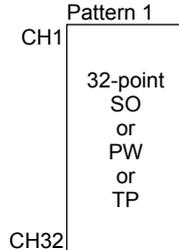

F11E.ai

ADV869 (ST5)

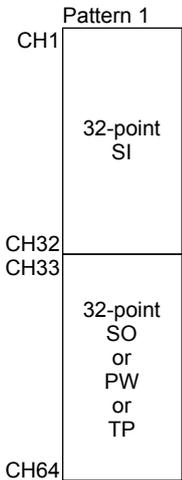

ADV169 (ST6)

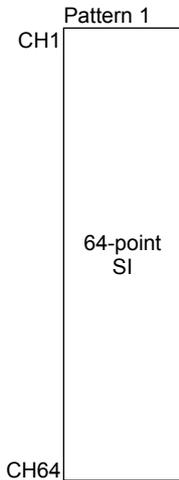

ADV569 (ST7)

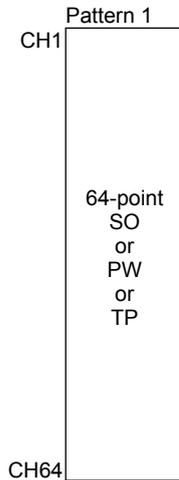

F12E.ai

For PW (pulse width output), use two contiguous terminal numbers; the first of these must be odd-numbered. If both PW and TP (time-proportioning ON/OFF output) are used together, successive pairs of terminals must be either PW or TP terminals, as shown in the example below.

Example:

Terminals 1 and 2	PW (one PW output, two contiguous terminal nos.)
Terminals 3 and 4	TP (two outputs, two contiguous terminal nos.)
Terminals 5 and 6	TP (two outputs, two contiguous terminal nos.)
⋮	⋮
Terminals 15 and 16	PW (one PW output, two contiguous terminal nos.)

For PW output, use two contiguous terminal numbers; the first of these must be odd-numbered. Also if SO and TP terminals are used together with PW, individual terminals that are not PW can be either SO or TP terminals.

Example:

Terminals 1 and 2	PW (one PW output, two contiguous terminal nos.)
Terminal 3	TP or SO
Terminal 4	TP or SO
⋮	⋮
Terminal 16	TP or SO

EXTERNAL DIMENSIONS

● ADV151, ADV551 Digital I/O Module

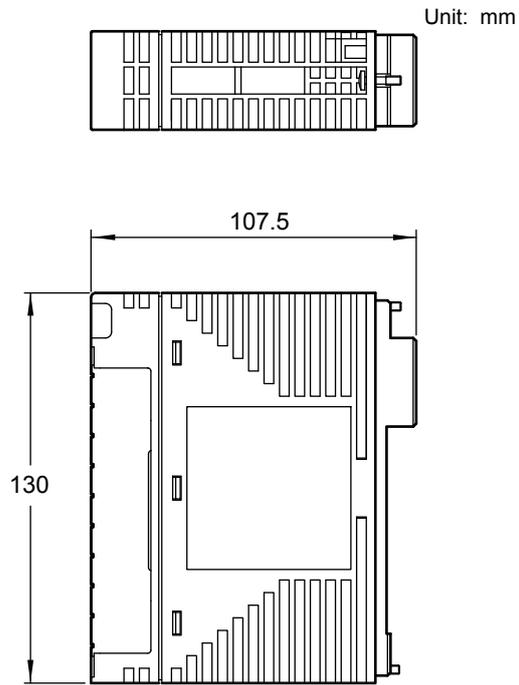

● ADV141, ADV142, ADR541 Digital I/O Module

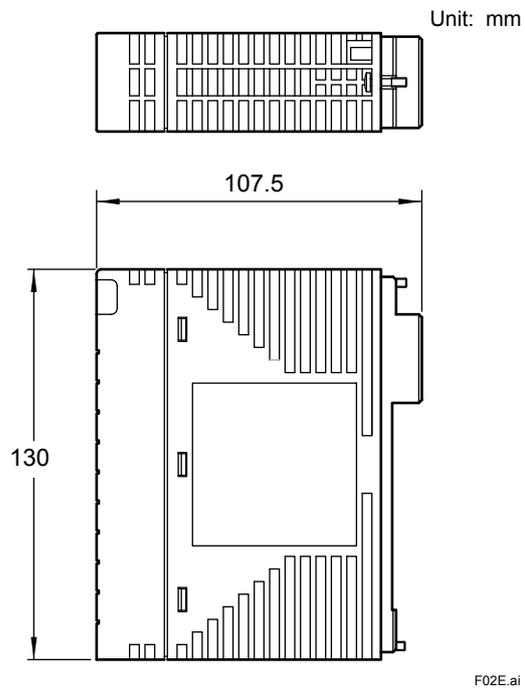

● ADV157, ADV557 Digital I/O Module

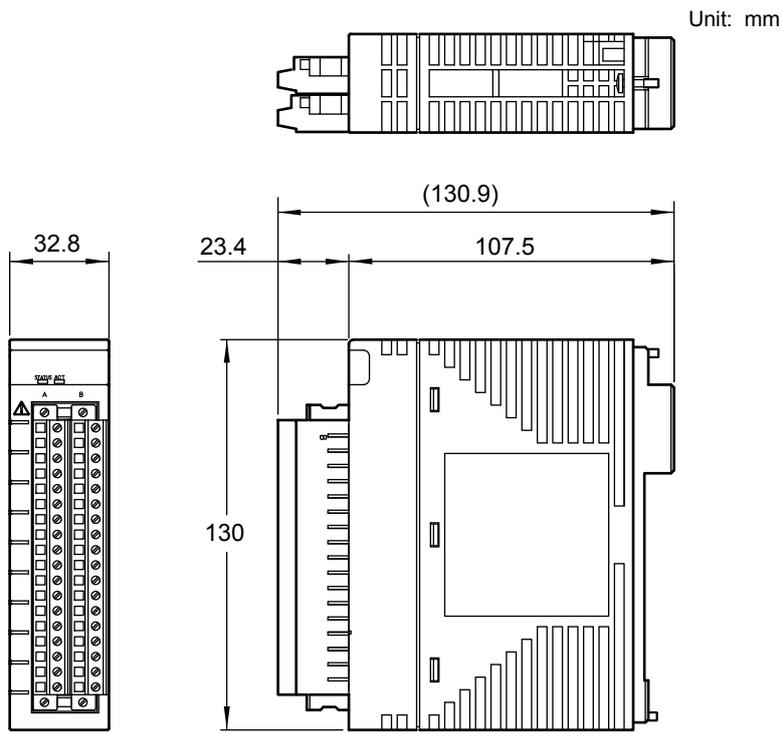

F03E.ai

● ADV161, ADV561 Digital I/O Module

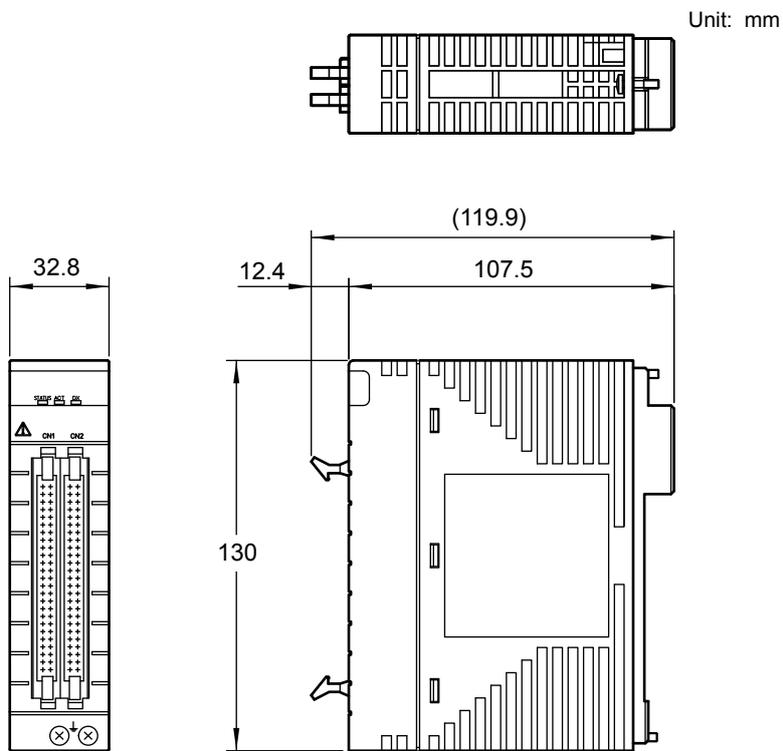

F04E.ai

● ADV859, ADV159, ADV559 Digital I/O Module for Compatible ST

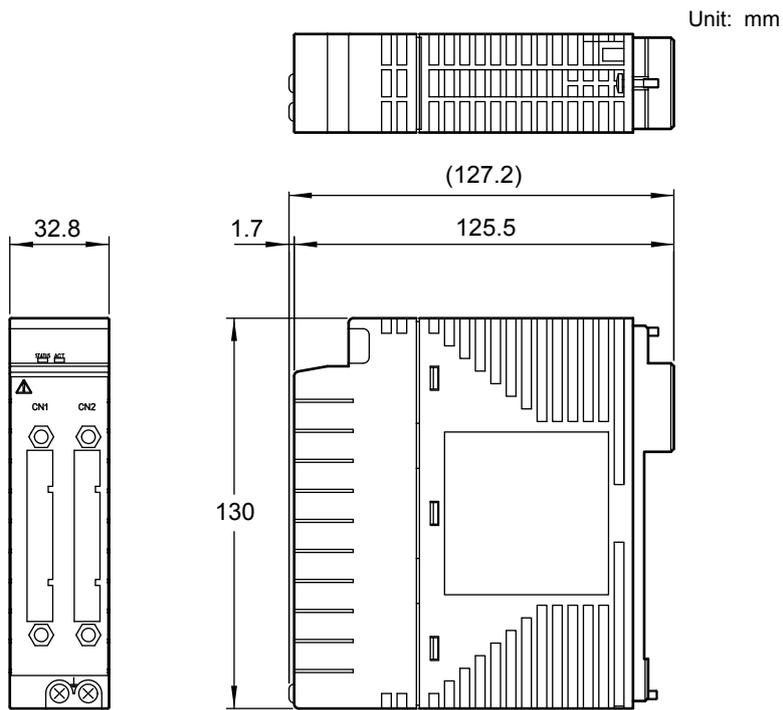

● ADV869, ADV169, ADV569 Digital I/O Module for Compatible ST

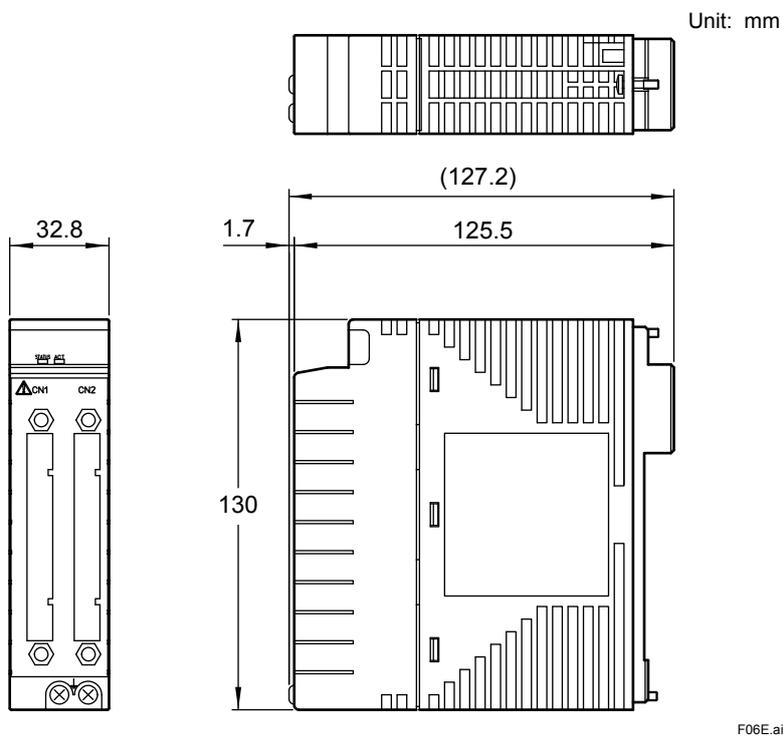

■ MODELS AND SUFFIX CODES

Digital Input Module

		Description
Model	ADV151	Digital Input Module (32-channel, 24 V DC, Isolated)
Suffix Codes	-P	With pushbutton input
	-E	With SOE capture (*1)
	5	Without status display; with no explosion protection
	6	With status display; with no explosion protection
	E	Without status display; with explosion protection
	F	With status display; with explosion protection
Option Codes	0	Basic type
	3	With ISA Standard G3 option and temperature (-20 to 70 °C) option
	/D5A00	With KS Cable Interface Adapter for 32-channel digital [Model: ATD5A-00]
	/B5S00	With Pressure Clamp Terminal Block for Digital Input [Model: ATB5S-00]
	/B5S10	With Pressure Clamp Terminal Block for Digital Input (surge absorber) [Model: ATB5S-10]
	/B5D00	With Dual Pressure Clamp Terminal Block for Digital Input [Model: ATB5D-00]
	/B5D10	With Dual Pressure Clamp Terminal Block for Digital Input (surge absorber) [Model: ATB5D-10]
	/CCC01	With Connector Cover for MIL Cable [Model: ACCC01]

*1: Please refer to GS 33K30D10-50E when using it with the Vnet/IP system, and GS 33K30D20-50E when using it with the Vnet system.

		Description
Model	ADV141	Digital Input Module (16-channel, 100V - 120 V AC, Isolated)
Suffix Codes	-P	With pushbutton input
	5	Without status display; with no explosion protection
	E	Without status display; with explosion protection
	0	Basic type
	3	With ISA Standard G3 option and temperature (-20 to 70 °C) option
Option Code	/C4S50	With Pressure Clamp Terminal Block for Digital [Model : ATC4S-50]

		Description
Model	ADV142	Digital Input Module (16-channel, 200 V - 240 V AC, Isolated)
Suffix Codes	-P	With pushbutton input
	0	General-purpose type
	0	Basic type
	3	With ISA Standard G3 option and temperature (-20 to 70 °C) option
Option Code	/C4S60	With Pressure Clamp Terminal Block for Digital [Model : ATC4S-60]

		Description
Model	ADV157	Digital Input Module (32-channel, 24V DC, Pressure Clamp Terminal support only, Isolated)
Suffix Codes	-S	Standard type
	5	With no explosion protection
	E	With explosion protection
	0	Basic type
	1	With ISA Standard G3 option

		Description
Model	ADV161	Digital Input Module (64-channel, 24 V DC, Isolated)
Suffix Codes	-P	With pushbutton input
	5	Without status display; with no explosion protection
	E	Without status display; with explosion protection
	0	Basic type
	1	With ISA Standard G3 option

Digital Output Module

		Description
Model	ADV551	Digital Output Module (32-channel, 24 V DC, Isolated)
Suffix Codes	-P	With pulse width output function/time-proportional output function
	5	Without status display; with no explosion protection
	6	With status display; with no explosion protection
	E	Without status display; with explosion protection
	F	With status display; with explosion protection
	0	Basic type
Option Codes	3	With ISA Standard G3 option and temperature (-20 to 70 °C) option
	/D5A00	With KS Cable Interface Adapter for 32-channel Digital [Model : ATD5A-00]
	/D5S00	With Pressure Clamp Terminal Block for Digital Output [Model : ATD5S-00]
	/D5S10	With Pressure Clamp Terminal Block for Digital Output (surge absorber) [Model : ATD5S-10]
	/D5D00	With Dual Pressure Clamp Terminal Block for Digital Output [Model : ATD5D-00]
	/D5D10	With Dual Pressure Clamp Terminal Block for Digital Output (surge absorber) [Model : ATD5D-10]
	/CCC01	With Connector Cover for MIL Cable [Model : ACCC01]

		Description
Model	ADR541	Relay Output Module (16-channel, 24 to 110 V DC/100 to 240 V AC, Isolated)
Suffix Codes	-P	With pulse width output function/time-proportional output function
	5	Without status display; with no explosion protection
	E	Without status display; with explosion protection
	0	Basic type
	3	With ISA Standard G3 option and temperature (-20 to 70 °C) option
Option Code	/C4S70	With Pressure Clamp Terminal Block for Digital Input [Model : ATC4S-70]

		Description
Model	ADV557	Digital Output Module (32-channel, 24 V DC, Pressure Clamp Terminal support only, Isolated)
Suffix Codes	-S	Standard type
	5	With no explosion protection
	E	With explosion protection
	0	Basic type
	1	With ISA Standard G3 option

		Description
Model	ADV561	Digital Output Module (64-channel, 24 V DC, Isolated)
Suffix Codes	-P	With pulse width output function/time-proportional output function
	5	Without status display; with no explosion protection
	E	Without status display; with explosion protection
	0	Basic type
	1	With ISA Standard G3 option

Digital I/O Module

		Description
Model	ADV859	Digital I/O Module for Compatible ST2 (16-channel input/16-channel output, Isolated channels)
Suffix Codes	-P	With pulse width function/time-proportional output function
	0	Always 0
	0	Basic type
	1	With ISA Standard G3 option

		Description
Model	ADV159	Digital Input Module for Compatible ST3 (32-channel, Isolated channels)
Suffix Codes	-P	With pushbutton input
	0	Always 0
	0	Basic type
	1	With ISA Standard G3 option

		Description
Model	ADV559	Digital Output Module for Compatible ST4 (32-channel output, Isolated channels)
Suffix Codes	-P	With pulse width function/time-proportional output function
	0	Always 0
	0	Basic type
	1	With ISA Standard G3 option

		Description
Model	ADV869	Digital I/O Module for Compatible ST5 (32-channel input/32-channel output, Isolated, Common Minus Side Every 16-channel)
Suffix Codes	-P	With pulse width function/time-proportional output function
	0	Always 0
	0	Basic type
	1	With ISA Standard G3 option

		Description
Model	ADV169	Digital Input Module for Compatible ST6 (64-channel, Isolated, Common Minus Side Every 16-channel)
Suffix Codes	-P	Standard type
	0	Always 0
	0	Basic type
	1	With ISA Standard G3 option

		Description
Model	ADV569	Digital Output Module for Compatible ST7 (64-channel output, Isolated, Common Minus Side Every 16-channel)
Suffix Codes	-P	With pulse width function/time-proportional output function
	0	Always 0
	0	Basic type
	1	With ISA Standard G3 option

■ ORDERING INFORMATION

Specify the model and suffix codes.

For selecting the right products for explosion protection, please refer to TI 33Q01J30-01E without fail.

■ TRADEMARK

- CENTUM is a registered trademark of Yokogawa Electric Corporation.
- Other company and product names appearing in this document are trademarks or registered trademarks of their respective holders.